



finder[®]
SWITCH TO THE FUTURE

Step relays 10 A



Lighting control
in corridors (for
hotels, offices
and hospitals)



Bedroom
light control



Living room
light control



27
SERIES

1 or 2 Pole electromechanical step relay, for electrically common coil and contact circuits

27.0x - Connect up to 24 illuminated push buttons with the addition of module 027.00

27.2x - Connect up to 15 illuminated push buttons (without additional module) - incorporates coil power limiter to permit continuous coil energisation

- Choice of 3 switching sequences
- Screw terminal connections
- AC coil
- Panel mount
- Cadmium free contact material
- Italian Patent

27.0x / 2x
Screw terminal



For outline drawing see page 5

Contact specification

Number of contacts	1 or 2		1 or 2
Rated current/Maximum peak current	A		10/20
Rated voltage/ Maximum switching voltage	V AC	110/—	230/—
Rated load AC1	VA	1100	2300
Rated load AC15	VA	250	500
Nominal lamp rating:			
230 V incandescent/halogen W	—	1000	1000
fluorescent tubes with electronic ballast W	200	400	400
fluorescent tubes with electromechanical ballast W	180	360	360
CFL W	100	200	200
230 V LED W	—	200	200
LV halogen or LED with electronic ballast W	100	200	200
LV halogen or LED with electromechanical ballast W	200	400	400
Minimum switching current	mW (V/mA)	10	
Standard contact material		AgNi	

Coil specification

Nominal voltage (U _N)	V AC (50/60 Hz)	110	230	230
	V DC	—		
Pickup/continuous power	VA (50 Hz)	4/4		25/1
Operating range	AC 50 Hz/AC 60 Hz	(0.8...1.1)U _N / (0.85...1.1)U _N		
	DC	—		

Technical data

Mechanical life AC/DC	cycles	300 · 10 ³		300 · 10 ³
Electrical life at rated load in AC1	cycles	100 · 10 ³		100 · 10 ³
Max no. of illuminated push-button	(≤ 1 mA)	4 (24 with module 027.00)		15
Minimum/Maximum impulse duration		0.1 s/1 h (according to EN 60669)		0.1 s/continuous
Ambient temperature range	°C	-40...+40		-40...+40
Protection category		IP 20		IP 20

Approvals (according to type)



27.0x



- Single or 2 double phase switch 1 NO (SPST-NO) or 2 NO (DPST-NO)

27.01

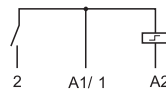

27.05 - 27.06

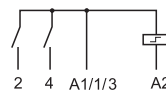

27.2x EVO



- Single or 2 double phase switch 1 NO (SPST-NO) or 2 NO (DPST-NO) with coil power limiter

27.21



27.25 - 27.26

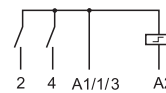

Ordering information

Example: 27 series screw terminal, panel mount step relay, single phase switch 1 NO (SPST-NO) 10 A contact, coil rated 230 V AC.

27.01.8.230.0.0.0.0

- Series** ——— 27
- Type** ——— 0 = Clamp terminal
2 = Clamp terminal, with coil power limiter
- No. of poles** ——— 1 = Single phase switch 1 NO (SPST-NO)
5 = 4 sequences double phase switch 2 NO (DPST-NO)
6 = 3 sequences double phase switch 2 NO (DPST-NO)
- Coil voltage** ——— See coil specifications
- Coil version** ——— 8 = AC (50/60 Hz)

Technical data

Other data		27.01, 27.21		27.05, 27.06, 27.25, 27.26	
Power lost to the environment with rated current and coil de-energised	W	0.9		1.8	
Screw torque	Nm	0.8		0.8	
Max. wire size		solid cable	stranded cable	solid cable	stranded cable
	mm ²	2 x 2.5	1 x 4 / 2 x 2.5	2 x 2.5	1 x 4 / 2 x 2.5
	AWG	2 x 14	1 x 12 / 2 x 14	2 x 14	1 x 12 / 2 x 14

Coil specifications

Types 27.01, 27.05, 27.06

Nominal voltage U_N	Coil code	Operating range (50 Hz)		Resistance R	Consumption I at U_N (50 Hz)
		U_{min}	U_{max}		
V		V	V	Ω	mA
110	8.110	88	121	1400	42.0
230	8.230	184	253	6500	17.5

Type	Number of steps	Sequence			
		1	2	3	4
27.01/21	2				
27.05/25	4				
27.06/26	3				

Types 27.21, 27.25, 27.26

Nominal voltage U_N	Coil code	Operating range (50 Hz)		Resistance R	Consumption	
		U_{min}	U_{max}		pick up I at U_N (50 Hz)	continuous I at U_N (50 Hz)
V		V	V	Ω	mA	mA
230	8.230	184	253	1250	100	4

Wiring diagram

Type 27.01/05/06

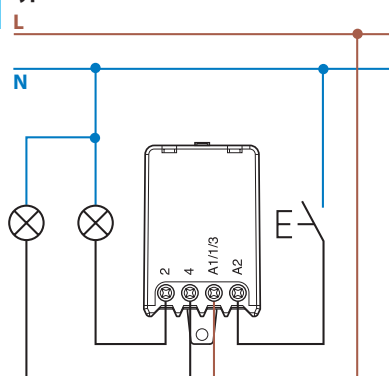

Type 27.21/25/26

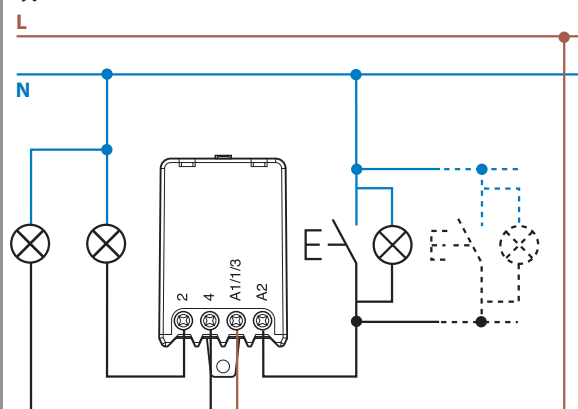

Accessories for types 27.01, 27.05, 27.06

Module for illuminated push-button (230 V AC applications)

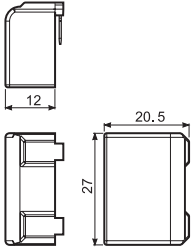

Type 027.00

This module is necessary if using up to a maximum of 24 illuminated push-buttons (1 mA max, 230 V AC) in the switching input circuit. It must be plugged directly into the relay.

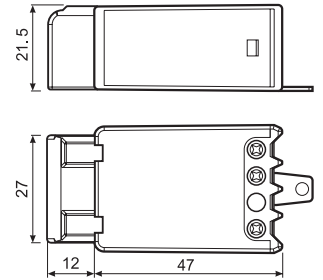

Type 27.0x + 027.00

Outline drawings

27.0x / 2x
Screw terminal

